







CONTENTS

CODE KEY	4-5	HIGH-FEED MILLING	12-17
PRODUCT GUIDE	6-9	FM1/EM1	
MILLING CUTTER PITCH	10-11	SHOULDER MILLING	18-25
TECHNICAL INFORMATION	46-51	FM2/EM2	
		PROFILE MILLING	26-31
		FM3/EM3	
		FACE MILLING	32-36
		FM4/EM4	
		CHAMFER MILLING	37
		EM5	
		THREADING MILLING	38-41
		FM7/EM7	
		GROOVE MILLING	42-45
		FM8/EM8	





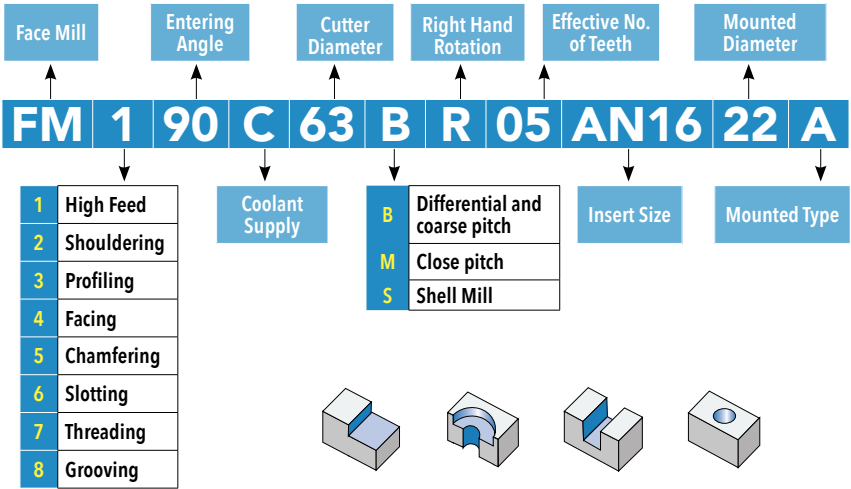



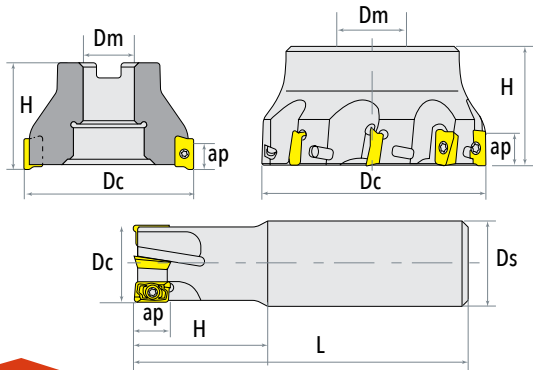





FACE MILL CODE KEY













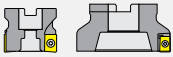







D_c	Cutter Diameter
D_m	Mounted Diameter
D_s	Shank Diameter
H	Cutter Height
L	Overall Length
a_p	Axial Depth of Cut



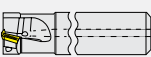







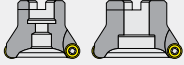



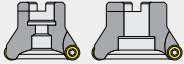





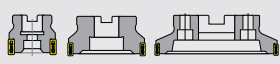



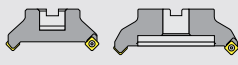

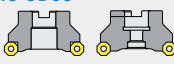





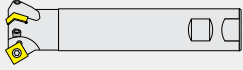

	SERIES/SHAPE	APPLICABLE INSERTS	FEATURES	PAGES
HIGH-FEED MILLING	FM1-90C-NL06/09 	NLMP 	<ul style="list-style-type: none">• Diameter Range: $\phi 40\text{-}\phi 100\text{mm}$• High-feed application• Through coolant• Double sided negative insert with positive cutting	p.12
	EM1-90C-NL06/09 	NLMP 	<ul style="list-style-type: none">• Diameter Range: $\phi 16\text{-}\phi 32\text{mm}$• High-feed application• Through coolant• Double sided negative insert with positive cutting	p.12
	FM1-90C-JD12/JP17 	JDMT 	<ul style="list-style-type: none">• Diameter Range: $\phi 50\text{-}\phi 100\text{mm}$• High-feed application• Through coolant	p.14
	EM1-90C-JD08/12 	JDMT 	<ul style="list-style-type: none">• Diameter Range: $\phi 20\text{-}\phi 35\text{mm}$• High-feed application• Through coolant	p.14
	FM1-90C-SD12/15 	SDMT 	<ul style="list-style-type: none">• Diameter Range: $\phi 50\text{-}\phi 100\text{mm}$• Suitable for rough machining large mold.• Through coolant	p.16
	EM1-90C-SD12 	SDMT 	<ul style="list-style-type: none">• Diameter Range: $\phi 32\text{-}\phi 40\text{mm}$• Through coolant• High rigidity	p.16

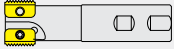
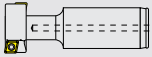

	SERIES/SHAPE	APPLICABLE INSERTS	FEATURES	PAGES
SHOULDER MILLING	FM2-90C-AN12/16 	ANKX 	<ul style="list-style-type: none"> • Diameter Range: $\phi 50\text{-}\phi 125\text{mm}$ • Square Shoulder application • Double sided negative insert with positive cutting • High material removal rate 	p.18
	FM2-90C-AN12/16 	ANKX 	<ul style="list-style-type: none"> • Diameter Range: $\phi 50\text{-}\phi 80\text{mm}$ • Square Shoulder application • Double sided negative insert with positive cutting • High material removal rate 	p.18
	EM2-90C-AN12/16 	ANKX 	<ul style="list-style-type: none"> • Diameter Range: $\phi 32\text{-}\phi 40\text{mm}$ • Square Shoulder application • High rigidity 	p.19
	FM2-90C-AP10 	APKT 	<ul style="list-style-type: none"> • Diameter Range: $\phi 40\text{-}\phi 100\text{mm}$ • Square Shoulder application • High rigidity 	p.20
	EM2-90C-AP10 	APKT 	<ul style="list-style-type: none"> • Diameter Range: $\phi 10\text{-}\phi 20\text{mm}$ • Square Shoulder application • High rigidity 	p.20
	FM2-90C-R390 	R390 	<ul style="list-style-type: none"> • Diameter Range: $\phi 40\text{-}\phi 80\text{mm}$ • Square Shoulder application • High rigidity 	p.22
	EM2-90C-R390 	R390 	<ul style="list-style-type: none"> • Diameter Range: $\phi 16\text{-}\phi 32\text{mm}$ • Square Shoulder application • Through Coolant 	p.22
	FM2-90C-WN08 	WNGU 	<ul style="list-style-type: none"> • Diameter Range: $\phi 50\text{-}\phi 160\text{mm}$ • Square Shoulder application • Double sided negative insert with positive cutting • High material removal rate 	p.24
	FM2-90C-WN04 	WNGU 	<ul style="list-style-type: none"> • Diameter Range: $\phi 20\text{-}\phi 40\text{mm}$ • Square Shoulder application • Double sided negative insert with positive cutting • High material removal rate 	p.24

	SERIES/SHAPE	APPLICABLE INSERTS	FEATURES	PAGES
PROFILE MILLING	FM3-90-RD10/12/16 	RD 	<ul style="list-style-type: none"> • Diameter Range: $\phi 50\text{-}\phi 125\text{mm}$ • Profile Milling application • High rigidity 	p.26
	EM3-90-RD08/10/12 	RD 	<ul style="list-style-type: none"> • Diameter Range: $\phi 17\text{-}\phi 32\text{mm}$ • Profile Milling application • High rigidity 	p.26
	FM3-90-RC12/16 	RCKT 	<ul style="list-style-type: none"> • Diameter Range: $\phi 50\text{-}\phi 100\text{mm}$ • Profile Milling application • High rigidity 	p.28
	EM3-90-RC10/12 	RCKT 	<ul style="list-style-type: none"> • Diameter Range: $\phi 20\text{-}\phi 40\text{mm}$ • Profile Milling application • High rigidity 	p.28
	EM3-90-BN12/16/20/25/30/32 	BN 	<ul style="list-style-type: none"> • Diameter Range: $\phi 12\text{-}\phi 32\text{mm}$ • Profile Milling application • High rigidity 	p.30
FACE MILLING	FM4-90-LN15 	LN*T 	<ul style="list-style-type: none"> • Diameter Range: $\phi 50\text{-}\phi 160\text{mm}$ • Face Milling application • Double sided negative insert with positive cutting • High material removal rate 	p.32
	DM4-90-LN15 	LN*T 	<ul style="list-style-type: none"> • Diameter Range: $\phi 80\text{-}\phi 160\text{mm}$ • Face Milling application • Double sided negative insert with positive cutting • High material removal rate 	p.32
	FM4-45C-SN12 	SNMX 	<ul style="list-style-type: none"> • Diameter Range: $\phi 50\text{-}\phi 125\text{mm}$ • Face Milling application • Double sided negative insert with positive cutting • High material removal rate 	p.34
	FM4-43-OD06 	OD*T 	<ul style="list-style-type: none"> • Diameter Range: $\phi 50\text{-}\phi 125\text{mm}$ • Face Milling application • High rigidity 	p.35
	FM4-45-SE13 	SE*T 	<ul style="list-style-type: none"> • Diameter Range: $\phi 50\text{-}\phi 125\text{mm}$ • Face Milling application • High rigidity 	p.36

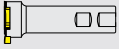

	SERIES/SHAPE	APPLICABLE INSERTS	FEATURES	PAGES
CHAMFER MILLING	EM5-SP09/12 	SPMT 	<ul style="list-style-type: none"> • Diameter Range: $\varnothing 25\text{-}\varnothing 32\text{mm}$ • Chamfer Milling application • High rigidity 	p.37
THREAD MILLING	FM7-TM 	TM-ISO TM-UN60 TM-W 55° TM-BSPT 55° TM-NPT 60° 	<ul style="list-style-type: none"> • Diameter Range: $\varnothing 63\text{-}\varnothing 100\text{mm}$ • Thread Milling application • High rigidity 	p.38
	FM7-MT 		<ul style="list-style-type: none"> • Diameter Range: $\varnothing 12\text{-}\varnothing 50\text{mm}$ • Thread Milling application • High rigidity 	p.38
GROOVE MILLING	EM8-90 	CCMT 	<ul style="list-style-type: none"> • Diameter Range: $\varnothing 25\text{-}\varnothing 50\text{mm}$ • T-Slot Grooving application • High rigidity 	p.42
	FM8-GM16 	GM16 	<ul style="list-style-type: none"> • Diameter Range: $\varnothing 54\text{-}\varnothing 80\text{mm}$ • Grooving application • High rigidity 	p.43
	EM8-GM16 	GM16 	<ul style="list-style-type: none"> • Diameter Range: $\varnothing 20\text{-}\varnothing 40\text{mm}$ • Grooving application • High rigidity 	p.43

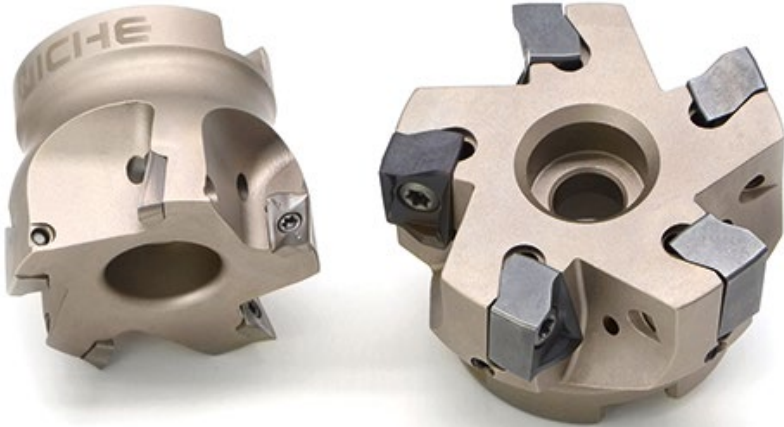

CHOOSING MILLING CUTTER PITCH

In milling selecting the correct cutter pitch is very important because it effects productivity, stability and power consumption. In choosing the most suitable number of effective cutting edges for an operation, it's important to know the distance between the cutting edges or the pitch.

NUMBER OF CUTTING EDGES

Increasing the number of cutting edges allows the table feed to increase while retaining cutting speeds and feeds without generating heat at the cutting edge. Increasing the number of edges changes the design of the tool. A shorter

distances between tool edges means there is less space for chip evacuation and even pitch.

Power requirement is often a factor that limits the possible number of cutting edges that are engaged in cutting.

Close pitch design should be your first choice for general milling.

Coarse pitch design should be considered for unstable conditions and long overhangs

Extra close pitch design should be considered for higher feed rates and short chipping materials



DIFFERENTIAL PITCH

Differential-pitched cutters have unequal spacing of the teeth around the cutter. These cutters are advantageous because they break up harmonic vibrations, which in turn increases stability and reduces the risk of vibration. This is especially useful when milling with high width of cut, A_p , and long overhangs.

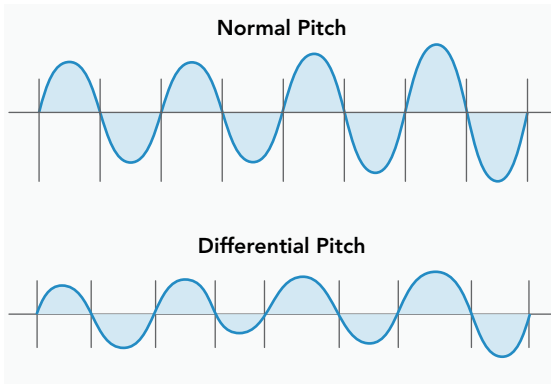

COARSE, CLOSE AND EXTRA CLOSE PITCH

There are normally three different pitches to choose from that can help you to optimize the application: coarse, close and extra close pitches.

The closer pitch cutters are used when stability is good and for low a_e applications. This ensures that more than one tooth always is engaged in cut.

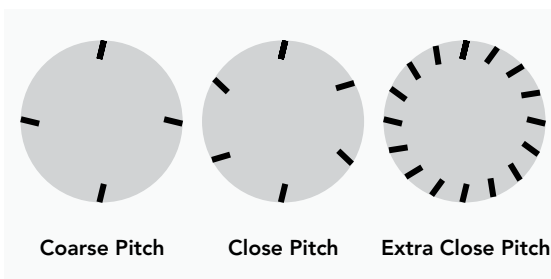

COARSE PITCH MILLING CUTTERS

Differential-pitched cutters – low number of edges.

- Best suited for unstable operations
- Limited power
- Extended tooling
- Full slotting operations
- Long-chipping materials ISO N

CLOSE PITCH MILLING CUTTERS

Even or differential pitched cutters – medium number of edges.

- Roughing in stable conditions
- Good productivity
- Good chip space for roughing in ISO P, M and S materials

EXTRA CLOSE PITCH MILLING CUTTERS

Even-pitched cutters – maximum number of inserts.

- First choice for high productivity with low a_p – more than one tooth is always engaged in cut
- Roughing and finishing in ISO K materials
- Roughing in ISO S materials in combination with round inserts



FACE MILL

FM1-90C-NL06/09

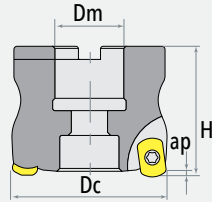

PRODUCT CODE		DIMENSIONS (mm)				INSERTS
		D _c	D _m	H	a _p	
FM1-90C40BR05NL06-16A	5	40	16	40	1,0	NLMP0603...
FM1-90C50BR06NL06-22A	6	50	22	40	1,0	NLMP0603...
FM1-90C63BR07NL06-22A	7	63	22	40	1,0	NLMP0603...
FM1-90C50BR06NL09-22A	6	50	22	50	1,5	NLMP0904...
FM1-90C63BR07NL09-22A	7	63	22	50	1,5	NLMP0904...
FM1-90C80BR08NL09-27A	8	80	27	50	1,5	NLMP0904...
FM1-90C100BR10NL09-32A	10	100	32	60	1,5	NLMP0904...

END MILL

EM1-90C-NL06/09

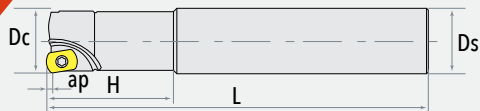

PRODUCT CODE		DIMENSIONS (mm)					INSERTS
		D _c	D _s	H	L	a _p	
EM1-90C16-C16-150-02NL06	2	16	16	40	150	0,7	NLMP0603...
EM1-90C17-C16-150-02NL06	2	17	16	40	150	0,7	NLMP0603...
EM1-90C20-C20-160-03NL06	3	20	20	80	160	1,0	NLMP0603...
EM1-90C21-C20-200-03NL06	3	21	20	20	200	1,0	NLMP0603...
EM1-90C25-C25-150-03NL09	3	25	25	70	150	1,5	NLMP0904...
EM1-90C26-C25-150-03NL09	3	26	25	30	150	1,5	NLMP0904...
EM1-90C32-C32-160-04NL09	4	32	32	70	160	1,5	NLMP0904...



INSERTS & ACCESSORIES

NLMP

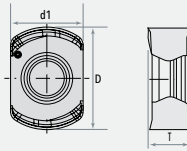





INSERT CODES	DIMENSIONS (mm)			GRADES
	D	d1	T	
NLMP0603R-L	9	6,39	3,73	NP5330 NC6325 NC3325 NP9330
NLMP0603R-M	9	6,39	3,73	
NLMP0603R-H	9	6,39	3,73	
NLMP0904R-L	11,9	9,16	4,80	
NLMP0904R-M	11,9	9,16	4,80	
NLMP0904R-H	11,9	9,16	4,80	

RAMPING PROGRAM

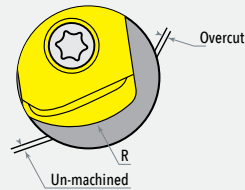
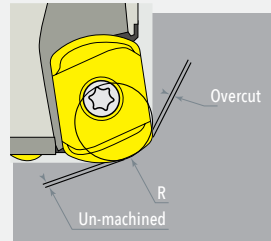
When applying CNC program with R, please note the overcut area. To avoid over-cut, please add to set up roughing stock – overcut mm. For other program R data, please refer to diagram below.

Inserts	Program R	Overcut	Un-machined
NLMP06	2,0	0,00	0,42
	2,5	0,12	0,26
	3,0	0,29	0,17
NLMP09	2,5	0,00	0,61
	3,0	0,09	0,45
	3,5	0,24	0,30
	4,0	0,41	0,17



INSERTS	SCREW 	WRENCH 	WRENCH 
NLMP0603...	ISM025064-NL06	T08	-
NLMP0904...	ISM035088-NL09	T10	-



FACE MILL

FM1-90C-JD12/JP17

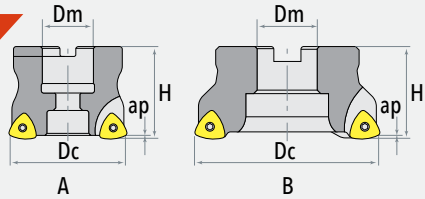

PRODUCT CODE		DIMENSIONS (mm)				INSERTS
		D_c	D_m	H	a_p	
FM1-90C50BR04JD12-22A	4	50	22	40	1,5	JDMT12T3...
FM1-90C63BR05JD12-22A	5	63	22	40	1,5	JDMT12T3...
FM1-90C63BR04JP17-22A	4	63	22	40	2,0	JPMT1705...
FM1-90C80BR05JP17-27A	5	80	27	50	2,0	JPMT1705...
FM1-90C100R06JP17-32B	6	100	32	50	2,0	JPMT1705...

END MILL

EM1-90C-JD08/12

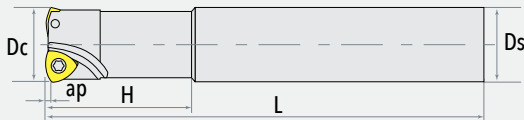

PRODUCT CODE		DIMENSIONS (mm)					INSERTS
		D_c	D_s	H	L	a_p	
EM1-90C20-C20-160-02JD08	2	20	20	50	160	1,0	JDMT0803...
EM1-90C25-C25-160-03JD08	3	25	25	50	160	1,0	JDMT0803...
EM1-90C25-C25-160-02JD12	2	25	25	50	160	1,5	JDMT12T3...
EM1-90C32-C32-200-03JD12	3	32	32	50	200	1,5	JDMT12T3...
EM1-90C35-C35-200-03JD12	3	35	35	50	200	1,5	JDMT12T3...



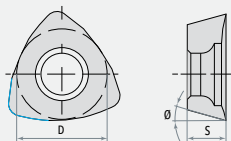

ACCESSORIES & INSERTS

J*MT



INSERT CODES	DIMENSIONS (mm)			GRADES
	D	S	ø	
JDMT080308-M	6,8	3,18	15	NP5330 NC6325 NC3325 NP9330
JDMT080308-H	6,8	3,18	15	
JDMT12T312-M	9,6	3,97	15	
JDMT12T312-H	9,6	3,97	15	
JPMT170520-M	13	5,56	11	

INSERTS	SCREW 	WRENCH 	WRENCH 
JDMT0803...	ISM025063-JD08	T08	-
JDMT12T3...	ISM040110-JD12	T15	W15
JPMT1705...	ISM050108-JP17	T20	W20



FACE MILL

FM1-90C-SD12/15

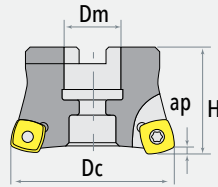

PRODUCT CODE		DIMENSIONS (mm)				INSERTS
		D_c	D_m	H	a_p	
FM1-90C50BR04SD12-22A	4	50	22	40	2	SDMT1205...
FM1-90C63BR05SD12-22A	5	63	22	40	2	SDMT1205...
FM1-90C63BR04SD15-22A	4	63	22	40	3	SDMT1505...
FM1-90C80BR05SD15-27A	5	80	27	50	3	SDMT1505...
FM1-90C100BR06SD15-32A	6	100	32	50	3	SDMT1505...

END MILL

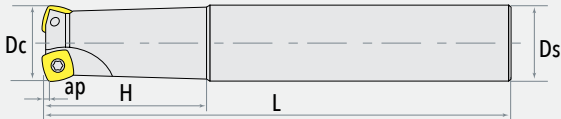

EM1-90C-SD12

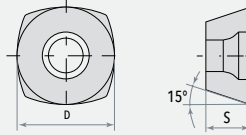

PRODUCT CODE		DIMENSIONS (mm)					INSERTS
		D_c	D_s	H	L	a_p	
EM1-90C32-C32-160-02SD12	2	32	32	70	160	2	SDMT1205...
EM1-90C35-C35-200-03SD12	3	35	35	70	200	2	SDMT1205...
EM1-90C40-C40-200-03SD12	3	40	40	70	200	2	SDMT1205...

INSERTS & ACCESSORIES
SDMT

INSERT CODES	DIMENSIONS (mm)			GRADES
	D	S	R	
SDMT120512-M	12,7	5,56	1,2	NP5330 NC6325 NC3325 NP9330
SDMT120512-H	12,7	5,56	1,2	
SDMT150512-M	15,875	5,56	1,2	
SDMT150512-H	15,875	5,56	1,2	

INSERTS	SCREW 	WRENCH 	WRENCH 
SDMT1205...	ISM040110-SD12	T15	W15
SDMT1505...	ISM050108-SD15	T20	W20



FACE MILL

FM2-90C-AN12/16

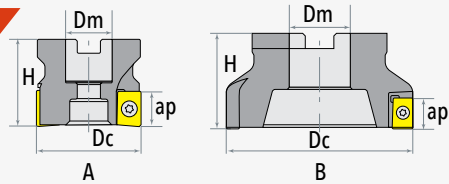

PRODUCT CODE		DIMENSIONS (mm)				INSERTS
		D_c	D_m	H	a_p	
FM2-90C50BR04AN12-22A	4	50	22	40	9	ANKX1207...
FM2-90C63BR05AN12-22A	5	63	22	40	9	ANKX1207...
FM2-90C50BR04AN16-22A	4	50	22	40	14	ANKX1607...
FM2-90C63BR05AN16-22A	5	63	22	40	14	ANKX1607...
FM2-90C80BR06AN16-27A	6	80	27	50	14	ANKX1607...
FM2-90C100BR08AN16-32B	8	100	32	50	14	ANKX1607...
FM2-90C125BR10AN16-40B	10	125	40	63	14	ANKX1607...

SHELL MILL

FM2-90C-AN12/16

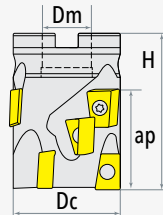

PRODUCT CODE		DIMENSIONS (mm)				INSERTS
		D_c	D_m	H	a_p	
FM2-90C50SR03AN12-22A	3/12	50	22	70	43	ANKX1207...
FM2-90C63SR04AN12-27A	4/16	63	27	70	43	ANKX1207...
FM2-90C50SR03AN16-22A	3/9	50	22	70	43	ANKX1607...
FM2-90C63SR04AN16-27A	4/12	63	27	85	57	ANKX1607...
FM2-90C80SR05AN16-32A	5/15	80	32	85	57	ANKX1607...



END MILL

EM2-90C-AN12/16

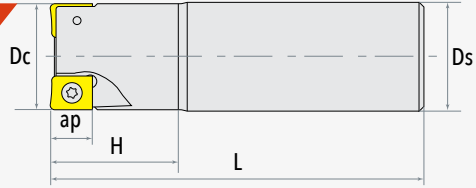

PRODUCT CODE		DIMENSIONS (mm)					INSERTS
		D _c	D _s	H	L	a _p	
EM2-90C32-C32-130-02AN12	2	32	32	40	130	9	ANKX1207...
EM2-90C40-C40-130-03AN12	3	40	40	40	130	9	ANKX1207...
EM2-90C32-C32-130-02AN16	2	32	32	40	130	14	ANKX1607...
EM2-90C32-C32-200-02AN16	2	32	32	50	200	14	ANKX1607...
EM2-90C40-C32-130-03AN16	3	40	32	50	130	14	ANKX1607...

INSERTS & ACCESSORIES

ANKX

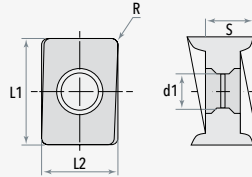

INSERT CODES	DIMENSIONS (mm)				GRADES
	L1	L2	S	d1	
ANKX120704R-L	12	10	8	4,6	NP5330 NC6325 NC3325 NP9330
ANKX120708R-M	12	10	8	4,6	
ANKX160708R-L	16	11,2	7,9	5,2	
ANKX160708R-M	16	11,2	7,9	5,2	
ANKX160716R-M	16	11,2	7,9	5,2	
ANKX160716R-H	16	11,2	7,9	5,2	

INSERTS	SCREW	WRENCH	WRENCH
ANKX1207...	ISM035120-AN12	T15	W15
ANKX1607...	ISM045100-AN16	T20	W20



FACE MILL

FM2-90C-AP10

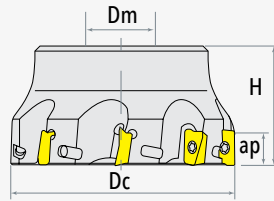

PRODUCT CODE		DIMENSIONS (mm)				INSERTS
		D_c	D_m	H	a_p	
FM2-90C-40MR06AP10-16A	6	40	16	40	10	APKT1003...
FM2-90C-50MR07AP10-22A	7	50	22	40	10	APKT1003...
FM2-90C-63MR09AP10-22B	9	63	22	40	10	APKT1003...
FM2-90C-80MR11AP10-27B	11	80	27	50	10	APKT1003...
FM2-90C-100MR13AP10-32B	13	100	32	50	10	APKT1003...

END MILL

EM2-90C-AP10

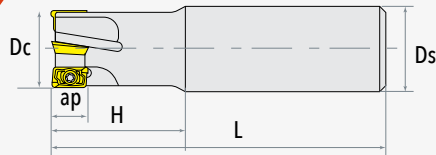

PRODUCT CODE		DIMENSIONS (mm)					INSERTS
		D_c	D_s	H	L	a_p	
EM2-90C10-W10-80-01AP10	1	10	10	20	80	10	APKT1003...
EM2-90C10-W16-80-01AP10	1	10	16	20	80	10	APKT1003...
EM2-90C12-W16-80-01AP10	1	12	16	20	80	10	APKT1003...
EM2-90C16-C16-150-02AP10	2	16	16	25	150	10	APKT1003...
EM2-90C18-W16-90-02AP10	2	18	16	30	90	10	APKT1003...
EM2-90C20-C20-160-02AP10	2	20	20	40	160	10	APKT1003...



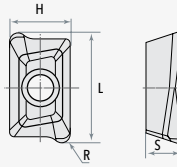

ACCESSORIES & INSERTS

APKT



INSERT CODES	DIMENSIONS (mm)			GRADES
	D	S	R	
APKT1003PDTR-L	10,95	6,7	3,55	NP5330
APKT100308PDTR-M	10,95	6,7	3,55	

INSERTS	SCREW 	WRENCH 	WRENCH 
APKT1003...	ISM025060-AP10	T08	-



FACE MILL

FM2-90C-R390

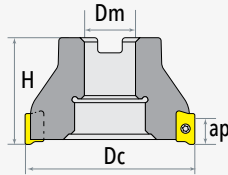

PRODUCT CODE		DIMENSIONS (mm)				INSERTS
		D _c	D _m	H	a _p	
FM2-90C40R04R390-16A	4	40	16	40	10	R390-11T3...
FM2-90C50R05R390-22A	5	50	22	40	10	R390-11T3...
FM2-90C63R06R390-22A	6	63	22	40	10	R390-11T3...
FM2-90C80R07R390-27A	7	80	27	50	10	R390-11T3...

END MILL

EM2-90C-R390

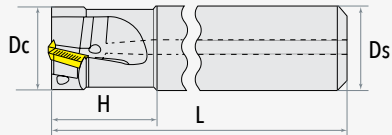

PRODUCT CODE		DIMENSIONS (mm)					INSERTS
		D _c	D _s	H	L	a _p	
EM2-90C16-C16-100-02R390	2	16	16	40	100	10	R390-11T3...
EM2-90C20-C20-100-02R390	2	20	20	40	100	10	R390-11T3...
EM2-90C25-C25-100-03R390	3	25	25	40	100	10	R390-11T3...
EM2-90C32-C32-100-03R390	3	32	32	40	100	10	R390-11T3...



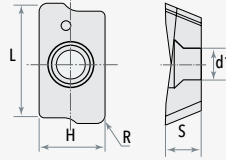

INSERTS & ACCESSORIES

R390



INSERT CODES	DIMENSIONS (mm)				GRADES
	L	H	S	d1	
R390-11T308-M	11	6,8	3,5	2,8	NP5330 NP9330 NM5300
R390-11T320-R	11	6,8	3,5	2,8	

INSERTS	SCREW 	WRENCH 	WRENCH 
R390-11T3...	ISM025080-390-11	T08	-



FACE MILL

FM2-90C-WN08

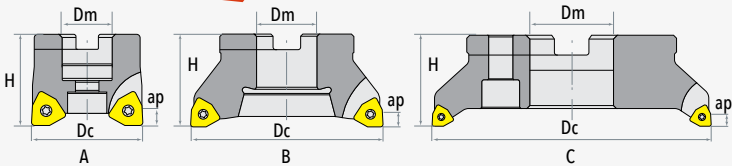

PRODUCT CODE		DIMENSIONS (mm)				INSERTS
		D _c	D _m	H	a _p	
FM2-90C50BR04WN08-22A	4	50	22	40	7,5	WNGU0806...
FM2-90C63BR05WN08-22A	5	63	22	40	7,5	WNGU0806...
FM2-90C80BR06WN08-27A	6	80	27	50	7,5	WNGU0806...
FM2-90C100BR07WN08-32B	7	100	32	50	7,5	WNGU0806...
FM2-90C125BR08WN08-40B	8	125	40	63	7,5	WNGU0806...
FM2-90C160BR12WN08-40C	12	160	40	63	7,5	WNGU0806...

END MILL

EM2-90C-WN04

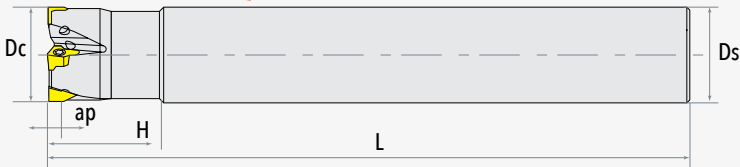

PRODUCT CODE		DIMENSIONS (mm)					INSERTS
		D _c	D _s	H	L	a _p	
EM2-90C20-C20-150-03WN04	3	20	20	30	150	4,0	WNGU0403..
EM2-90C25-C25-150-04WN04	4	25	25	30	150	4,0	WNGU0403..
EM2-90C32-C32-200-05WN04	5	32	32	30	200	4,0	WNGU0403..
EM2-90C35-C32-200-05WN04	5	35	32	30	200	4,0	WNGU0403..
EM2-90C40-C32-200-06WN04	6	40	32	30	200	4,0	WNGU0403..



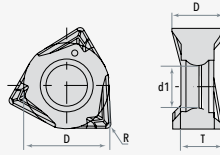

INSERTS & ACCESSORIES

WNGU



INSERT CODES	DIMENSIONS (mm)				GRADES
	D	d1	S	T	
WNGU040304-M	6,7	3,25	3,3	3,96	NP5330 NC6325 NC3325 NP9330
WNGU040308-M	6,7	3,25	3,3	3,96	
WNGU080608-M	12,48	4,6	6,45	7,9	
WNGU080608-H	12,48	4,6	6,45	7,9	

INSERTS	SCREW 	WRENCH 	WRENCH 
WNGU0403..	ISM025065-WN04	T08	-
WNGU0806...	ISM040110-WN08	T15	W15



FACE MILL

FM3-90-RD10/12/16

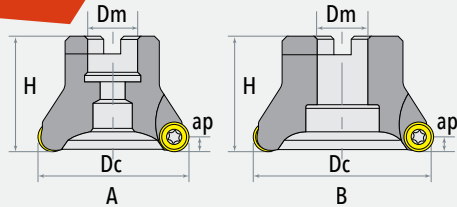

PRODUCT CODE		DIMENSIONS (mm)				INSERTS
		D_c	D_m	H	a_p	
FM3-90-50BR04RD10-22A	4	50	22	50	5	RD**10T3...
FM3-90-50BR04RD12-22A	4	50	22	50	6	RD**1204...
FM3-90-63BR05RD12-22A	5	63	22	50	6	RD**1204...
FM3-90-63BR04RD16-22A	4	63	22	50	8	RD**1604...
FM3-90-80BR05RD16-27A	5	80	27	50	8	RD**1604...
FM3-90-100BR06RD16-32B	6	100	100	50	8	RD**1604...
FM3-90-125BR07RD16-40B	7	125	125	63	8	RD**1604...

END MILL

EM3-90-RD08/10/12

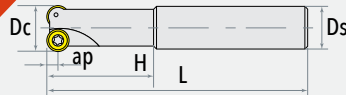



PRODUCT CODE		DIMENSIONS (mm)					INSERTS
		D_c	D_s	H	L	a_p	
EM3-90-17-C16-160-02RD08	2	17	16	60	160	4	RD**0803...
EM3-90-20-C20-160-02RD08	2	20	20	60	160	4	RD**0803...
EM3-90-20-C20-160-02RD10	2	20	20	50	160	5	RD**10T3...
EM3-90-25-C25-160-02RD10	2	25	25	50	160	5	RD**10T3...
EM3-90-32-C32-160-03RD12	3	32	32	50	160	6	RD**1204...

INSERTS & ACCESSORIES

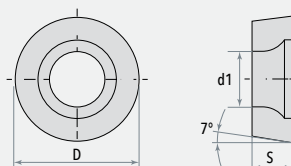
RD



INSERT CODES	DIMENSIONS (mm)			GRADES
	D	S	d1	
RDET0803M0-L	8	3,18	2,94	NP5330 NC6325 NC3325 NP9330
RDET0803M0-M	8	3,18	2,94	
RDEW0803M0T	8	3,18	2,94	
RDET10T3M0-L	10	3,97	4,4	
RDET10T3M0-M	10	3,97	4,4	
RDEW10T3M0T	10	3,97	4,4	
RDMT10T3M0-M	10	3,97	4,4	
RDMT10T3M0T	10	3,97	4,4	
RDET1204M0-L	12	4,76	4,4	
RDET1204M0-M	12	4,76	4,4	
RDEW1204M0T	12	4,76	4,4	
RDMT1204M0-M	12	4,76	4,4	
RDMW1204M0	12	4,76	4,4	
RDET1604M0-L	16	4,76	5,5	
RDET1604M0-M	16	4,76	5,5	
RDEW1604M0T	16	4,76	5,5	
RDMW1604M0T	16	4,76	5,5	

INSERTS	SCREW 	WRENCH 	WRENCH 
RD**0803...	ISM025065-RD08	T08	-
RD**10T3...	ISM040090-RD10	T15	W15
RD**1204...	ISM040090-RD12	T15	W15
RD**1604...	ISM050108-RD16	T20	W20



FACE MILL

FM3-90-RC12/16

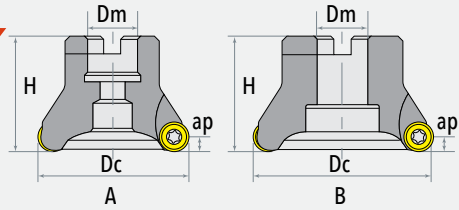

PRODUCT CODE		DIMENSIONS (mm)				INSERTS
		D_c	D_m	H	a_p	
FM3-90-50BR04RC12-22A	4	50	22	40	6	RCKT1204...
FM3-90-63BR05RC12-22A	5	63	22	40	6	RCKT1204...
FM3-90-63BR04RC16-22A	4	63	22	40	8	RCKT1606...
FM3-90-80BR06RC12-27A	6	80	27	50	6	RCKT1204...
FM3-90-80BR05RC16-27A	5	80	27	50	8	RCKT1606...
FM3-90-100BR06RC16-32B	6	100	32	50	8	RCKT1606...

END MILL

EM3-90-RC10/12

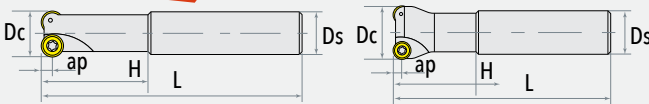

PRODUCT CODE		DIMENSIONS (mm)					INSERTS
		D_c	D_s	H	L	a_p	
EM3-90-20-C20-160-02RC10	2	20	20	50	160	5	RCKT10T3...
EM3-90-25-C20-160-02RC10	2	25	20	50	160	5	RCKT10T3...
EM3-90-32-C25-200-02RC12	2	32	25	50	200	6	RCKT1204...
EM3-90-40-C32-200-03RC12	3	40	32	50	200	6	RCKT1204...



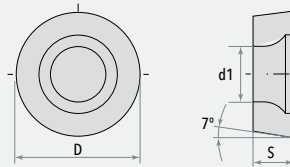

INSERTS & ACCESSORIES

RCKT



INSERT CODES	DIMENSIONS (mm)			GRADES
	D	S	d1	
RCKT10T3M0-M	10	3,97	4,4	NP5330 NC6325 NC3325 NP9330
RCKT1204M0-M	12	4,76	4	
RCKT1204M0-H	12	4,76	4	
RCKT1606M0-M	16	6,35	5,5	
RCKT1606M0-H	16	6,35	5,5	

INSERTS	SCREW 	WRENCH 	WRENCH 
RCKT10T3...	ISM040090-RC10	T15	W15
RCKT1204...	ISM035080-RC12	T15	W15
RCKT1606...	ISM050108-RC16	T20	W20

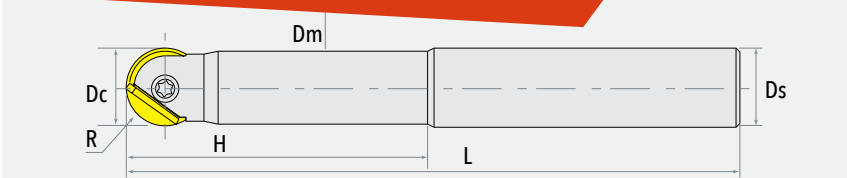
**END MILL****EM3-90-BN12/16/20/25/30/32**

PRODUCT CODE		DIMENSIONS (mm)						INSERTS
		D _c	D _s	D _m	H	L	R	
EM3-90-12-C12-100-01BN12	1	12	12	10,5	35	100	6	BN1200...
EM3-90-16-C16-100-01BN16	1	16	16	14,5	35	100	8	BN1600...
EM3-90-20-C20-110-01BN20	1	20	20	18,5	45	110	10	BN2000...
EM3-90-25-C25-130-01BN25	1	25	25	23,0	55	130	12,5	BN2500...
EM3-90-30-C32-150-01BN30	1	30	32	28,5	60	150	15	BN3000...
EM3-90-32-C32-150-01BN32	1	32	32	28,5	60	150	16	BN3200...



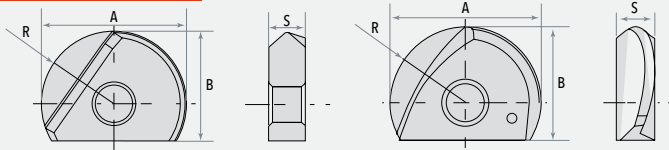

INSERTS & ACCESSORIES

BN



INSERT CODES	DIMENSIONS (mm)				GRADES
	R	A	B	S	
BN1200	6	12	10	3	NP5330 NC6325 NC3325 NP9330
BN1600	8	16	12	4	
BN2000	10	20	15	5	
BN2500	12,5	25	18,5	6	
BN3000	15	30	22,5	7	
BN3200	16	32	23,5	7	
BN1200-S	6	12	10	3	
BN1600-S	8	16	12	4	
BN2000-S	10	20	15	5	
BN2500-S	12,5	25	18,5	6	
BN3000-S	15	30	22,5	7	
BN3200-S	16	32	23,5	7	

INSERTS	SCREW 	WRENCH 	WRENCH 
BN1200...	ISM035095-BN12	T10	W10
BN1600...	ISM040140-BN16	T15	W15
BN2000...	ISM0050160-BN20	T20	W20
BN2500...	ISM060200-BN25	T20	W20
BN3000...	ISM080250-BN30	T30	W30
BN3200...	ISM080250-BN32	T30	W30



LNMT1506 FACE MILLING

FACE MILL

FM4-90-LN15

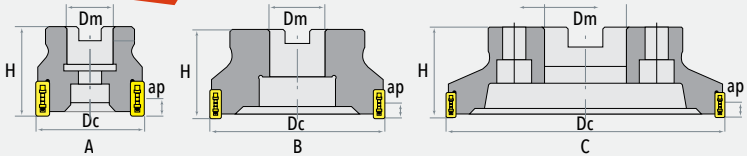

PRODUCT CODE		DIMENSIONS (mm)				INSERTS
		D_c	D_m	H	a_p	
FM4-90-50BR04LN15-22A	4	50	22	40	7	LN*T1506...
FM4-90-63BR05LN15-22A	5	63	22	40	7	LN*T1506...
FM4-90-80BR06LN15-27B	6	80	27	50	7	LN*T1506...
FM4-90-100BR08LN15-32B	8	100	32	50	7	LN*T1506...
FM4-90-125BR10LN15-40B	10	125	40	63	7	LN*T1506...
FM4-90-160BR12LN15-40C	12	160	40	63	7	LN*T1506...

DISC MILL

DM4-90-LN15

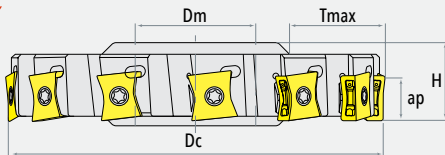

PRODUCT CODE		DIMENSIONS (mm)					INSERTS
		D_c	D_m	H	a_p	T_{max}	
DM4-90-80R08LN15-27-T18	8	80	27	24	14	18	LN*T1506...
DM4-90-100R10LN15-32-T23	10	100	32	26	14	23	LN*T1506...
DM4-90-125R12LN15-40-T32	12	125	40	26	14	32	LN*T1506...
DM4-90-160R15LN15-40-T49	15	160	40	26	14	49	LN*T1506...



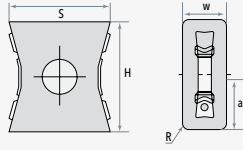

INSERTS & ACCESSORIES

LN*T



INSERT CODES	DIMENSIONS (mm)				GRADES
	H	W	a_p	S	
LNMT150608-M	15	6	7	13,9	NP5330 NC6325 NC3325 NP9330
LNMT150608-H	15	6	7	13,9	
LNMT150608-L	15	6	7	13,9	
LNMT150608-W	15,2	6	7	13,9	

INSERTS	SCREW 	WRENCH 	WRENCH 
LNMT1506...	ISM040110-LN15	T15	W15



SN*X1206 FACE MILLING

FACE MILL

FM4-45C-SN12

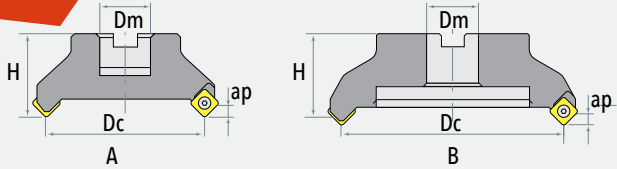

PRODUCT CODE		DIMENSIONS (mm)				INSERTS
		D _c	D _m	H	a _p	
FM4-45C50BR04SN12-22A	4	50	22	40	3	SNMX1206...
FM4-45C63BR06SN12-22A	6	63	22	40	3	SNMX1206...
FM4-45C80BR07SN12-27A	7	80	27	50	3	SNMX1206...
FM4-45C100BR08SN12-32B	8	100	32	50	3	SNMX1206...
FM4-45-125BR10SN12-40B	10	125	40	63	3	SNMX1206...

INSERTS & ACCESSORIES

SNMX

Note:
W: Wiper Inserts

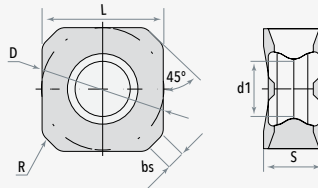

INSERT CODES	DIMENSIONS (mm)					GRADES
	L	D	S	bs	d1	
SNMX1206ANN-M	12,7	12,7	6,35	2,2	6,0	NP5330 NC6325 NC3325 NP9330
SNMX1206ANSN-H	12,7	12,7	6,35	2,2	6,0	
SNEX1206ANN-L	12,7	12,7	6,35	2,2	6,0	
SNEX1206ANN-M	12,7	12,7	6,35	2,2	6,0	
SNEX1206ANSN-H	12,7	12,7	6,35	2,2	6,0	
SNEX1206ANN-W	12,7	12,7	6,35	5,6	6,0	

INSERTS	SCREW	WRENCH	WRENCH
SNMX1206...	ISM040120-SN12	T15	W15



FACE MILL

FM4-43-OD06

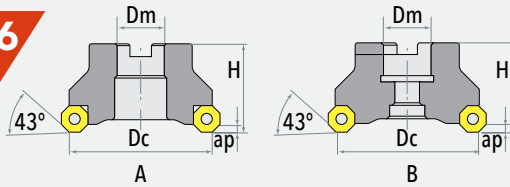

PRODUCT CODE		DIMENSIONS (mm)				INSERTS
		D _c	D _m	H	a _p	
FM4-43-50BR04OD06-22A	4	50	22	40	4	OD*T0605...
FM4-43-63BR05OD06-22A	5	63	22	40	4	OD*T0605...
FM4-43-80BR06OD06-27A	6	80	27	50	4	OD*T0605...
FM4-43-100BR07OD06-32B	7	100	32	50	4	OD*T0605...
FM4-43-125BR08OD06-40B	8	125	40	63	4	OD*T0605...

INSERTS & ACCESSORIES

OD*T

Note:
W: Wiper inserts
AL: Aluminium inserts

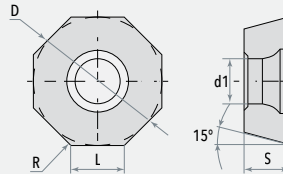

INSERT CODES	DIMENSIONS (mm)				GRADES
	L	D	S	d1	
ODMT060508-M	6,5	15,875	5,56	5,56	NP5330 NC6325 NC3325 NP9330
ODMT060508-H	6,5	15,875	5,56	5,56	
ODKT060508-L	6,5	15,875	5,56	5,56	
ODKT060508-M	6,5	15,875	5,56	5,56	
ODKT060508-H	6,5	15,875	5,56	5,56	
ODKT060508-W	6,5	15,875	5,56	5,56	
ODKT060508-AL	6,5	15,875	5,56	5,56	

INSERTS	SCREW	WRENCH	WRENCH
OD*T0605...	ISM050120-OD06	T20	W20



SE*T13T3 FACE MILLING

FACE MILL

FM4-45-SE13

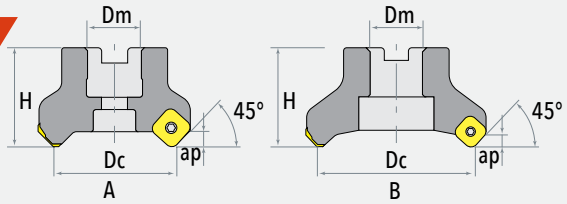

PRODUCT CODE		DIMENSIONS (mm)				INSERTS
		D _c	D _m	H	a _p	
FM4-45-50R04SE13-22A	4	50	22	40	4	SE*T13T3...
FM4-45-63R05SE13-22A	5	63	22	40	4	SE*T13T3...
FM4-45-80R06SE13-27B	6	80	27	50	4	SE*T13T3...
FM4-45-100R07SE13-32B	7	100	32	50	4	SE*T13T3...
FM4-45-125R08SE13-40B	8	125	40	50	4	SE*T13T3...

INSERTS & ACCESSORIES

SE*T

Note:
W: Wiper inserts
AL: Aluminium inserts

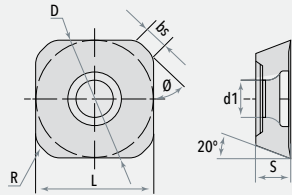

Insert Codes	DIMENSIONS (mm)					Grades
	L	D	S	bs	d1	
SEMT13T3AGSN-M	13,4	13,4	3,97	1,2	4,4	NP5330 NC6325 NC3325 NP9330
SEET13T3AGEN-L	13,4	13,4	3,97	1,7	4,4	
SEET13T3AGEN-M	13,4	13,4	3,97	1,2	4,4	
SEET13T3AGEN-H	13,4	13,4	3,97	1,3	4,4	
SEET13T3AGSN-M	13,4	13,4	3,97	1,2	4,4	
SEET13T3AGSN-H	13,4	13,4	3,97	1,3	4,4	
SEET13T3AGEN-W	13,4	13,4	3,97	2,37	4,4	
SEET13T3AGFN-AL	13,4	13,4	3,97	2,2	4,4	

INSERTS	SCREW	WRENCH	WRENCH
SE*T13T3...	ISM035080-SE13	T15	W15



END MILL

EM5-SP09/12

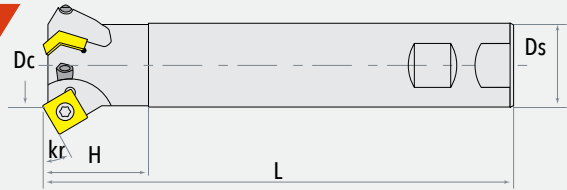

PRODUCT CODE		DIMENSIONS (mm)				k_r	a_p	INSERTS
		D_c	D_s	H	L			
EM5-30-25-C25-150-02SP09	2	25	25	40	150	30	3	SPMT09T3...
EM5-30-32-C32-200-03SP12	3	32	32	40	200	30	4,5	SPMT1204...
EM5-45-16-W16-100-01SP09	1	16	16	30	100	45	3	SPMT09T3...
EM5-45-25-C25-150-02SP09	2	25	25	40	150	45	5	SPMT09T3...
EM5-45-32-C32-200-03SP12	3	32	32	40	200	45	7	SPMT1204...
EM5-60-25-C25-150-02SP09	2	25	25	40	150	60	6	SPMT09T3...
EM5-60-32-C32-200-03SP12	3	32	32	40	200	60	8	SPMT1204...

INSERTS & ACCESSORIES

SPMT

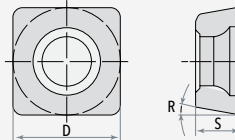

INSERT CODES	DIMENSIONS (mm)			GRADES
	D	S	R	
SPMT09T308-M	9,53	3,97	11	NP5330 NC6325 NC3325 NP9330
SPMT120408-M	12,7	4,76	11	

INSERTS	SCREW	WRENCH	WRENCH
SPMT09T3...	ISM040085-SP09	T15	-
SPMT1204...	ISM050110-SP12	T15	-



TM21/30/40 THREAD MILLING

FACE MILL

FM7-TM

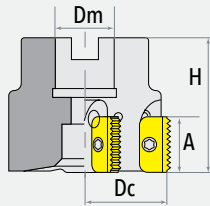

PRODUCT CODE		DIMENSIONS (mm)				INSERTS	PITCH	
		D _c	D _m	A	H		mm	TPI
FM7-63-05-TM21-22	5	63	22	10,4	50	TM21...	1.0-3.5	7-24
FM7-63-04-TM30-22	4	63	22	10,4	50	TM30...	1.5-5.0	6-20
FM7-80-04-TM30-27	4	80	27	12,4	55	TM30...	1.5-5.0	6-20
FM7-100-04-TM30-32	4	100	32	14,4	60	TM30...	1.5-5.0	6-20
FM7-80-04-TM40-27	4	80	27	12,4	55	TM40...	1.5-6.0	4-16
FM7-100-04-TM40-32	4	100	32	14,4	60	TM40...	1.5-6.0	4-16

END MILL

EM7-TM

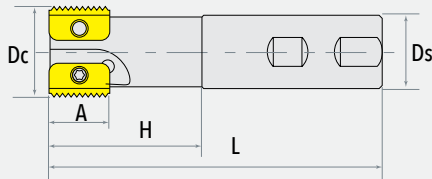

When the total length is over 100mm, we will choose cylinder straight shank.

PRODUCT CODE		DIMENSIONS (mm)				PITCH		INSERTS
		D _c	D _s	H	L	mm	TPI	
EM7-12-W20-90-01-TM14	1	12	20	16	85	0.5-1.5	16-32	TM14...
EM7-14.5-W20-90-01-TM14	1	14,5	20	25	85	0.5-2.5	10-32	TM14...
EM7-17-W20-90-01-TM14	1	17	20	30	85	0.5-2.5	10-32	TM14...
EM7-21-W20-90-01-TM21	1	21	20	40	95	1.0-3.5	7-24	TM21...
EM7-29-C25-110-01-TM30	1	29	25	50	110	1.5-5.0	6-20	TM30...
EM7-48-C40-160-01-TM40	1	48	40	78	160	1.5-6.0	4-16	TM40...
EM7-20-C20-100-02-TM14	2	20	20	45	100	0.5-2.5	10-32	TM14...
EM7-30-C25-120-02-TM21	2	30	25	55	120	1.0-3.5	7-24	TM21...
EM7-40-C32-150-02-TM30	2	40	32	70	150	1.5-5.0	6-20	TM30...
EM7-50-C40-160-02-TM40	2	50	40	80	160	1.5-6.0	4-16	TM40...



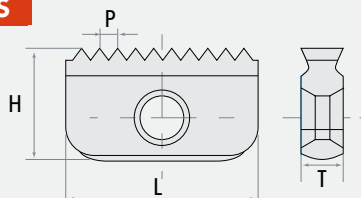

INSERTS & ACCESSORIES

TM-ISO



PRODUCT CODE	PITCH	DIMENSIONS (mm)		
		L	H	T
TM14N0.50ISO	0,50	14	7,5	3,1
TM14E/N0.75ISO	0,75	14	7,5	3,1
TM14E/N1.00ISO	1,00	14	7,5	3,1
TM14E/N1.25ISO	1,25	14	7,5	3,1
TM14E/N1.50ISO	1,50	14	7,5	3,1
TM14E/N2.00ISO	2,00	14	7,5	3,1
TM14E/N2.50ISO	2,50	14	7,5	3,1
TM21E/N1.00ISO	1,00	21	12	4,7
TM21E/N1.50ISO	1,50	21	12	4,7
TM21N1.75ISO	1,75	21	12	4,7
TM21E/N2.00ISO	2,00	21	12	4,7
TM21E/N2.50ISO	2,50	21	12	4,7
TM21E/N3.00ISO	3,00	21	12	4,7
TM21N3.50ISO	3,50	21	12	4,7
TM30E/N1.50ISO	1,50	30	16	5,5
TM30E/N2.00ISO	2,00	30	16	5,5

PRODUCT CODE	PITCH	DIMENSIONS (mm)		
		L	H	T
TM30E/N2.50ISO	2,50	30	16	5,5
TM30E/N3.00ISO	3,00	30	16	5,5
TM30E/N3.50ISO	3,50	30	16	5,5
TM30E/N4.00ISO	4,00	30	16	5,5
TM30N4.50ISO	4,50	30	16	5,5
TM30N5.00ISO	5,00	30	16	5,5
TM40E/N1.50ISO	1,50	40	20	6,3
TM40E/N2.00ISO	2,00	40	20	6,3
TM40E/N2.50ISO	2,50	40	20	6,3
TM40E/N3.00ISO	3,00	40	20	6,3
TM40N3.50ISO	3,50	40	20	6,3
TM40E/N4.00ISO	4,00	40	20	6,3
TM40N4.50ISO	4,50	40	20	6,3
TM40E/N5.00ISO	5,00	40	20	6,3
TM40E/N5.50ISO	5,50	40	20	6,3
TM40E/N6.00ISO	6,00	40	20	6,3

INSERTS	SCREW 	WRENCH 	WRENCH 
TM14...	ISM030070-TM14	T10	-
TM21...	ISM035100-TM21	T15	W15
TM30...	ISM040100-TM30	T15	W15
TM40...	ISM050140-TM40	T20	W20



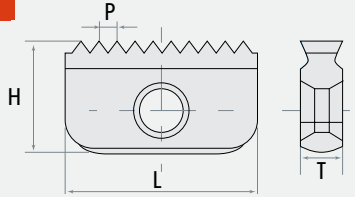

INSERTS & ACCESSORIES

TM-UN60



PRODUCT CODE	TPI	DIMENSIONS (mm)		
		L	H	T
TM14E/N32UN	32	14	7,5	3,1
TM14N28UN	28	14	7,5	3,1
TM14N27UN	27	14	7,5	3,1
TM14E/N24UN	24	14	7,5	3,1
TM14E/N20UN	20	14	7,5	3,1
TM14E/N18UN	28	14	7,5	3,1
TM14E/N16UN	16	14	7,5	3,1
TM14E/N14UN	14	14	7,5	3,1
TM14E/N12UN	12	14	7,5	3,1
TM14N11UN	11	14	7,5	3,1
TM14N10UN	10	14	7,5	3,1
TM21E/N24UN	24	21	12	4,7
TM21E/N20UN	20	21	12	4,7
TM21E/N18UN	18	21	12	4,7
TM21E/N16UN	16	21	12	4,7
TM21E/N14UN	14	21	12	4,7
TM21E/N12UN	12	21	12	4,7
TM21E/N11UN	11	21	12	4,7

PRODUCT CODE	TPI	DIMENSIONS (mm)		
		L	H	T
TM21E/N10UN	10	21	12	4,7
TM21N8UN	8	21	12	4,7
TM21N7UN	7	21	12	4,7
TM30E/N20UN	20	30	16	5,5
TM30E/N18UN	18	30	16	5,5
TM30E/N16UN	16	30	16	5,5
TM30E/N14UN	14	30	16	5,5
TM30E/N12UN	12	30	16	5,5
TM30E/N10UN	10	30	16	5,5
TM30E/N8UN	8	30	16	5,5
TM30E/N6UN	6	30	16	5,5
TM30E/N5UN	5	30	16	5,5
TM40E/N16UN	16	40	20	6,3
TM40E/N14UN	14	40	20	6,3
TM40E/N12UN	12	40	20	6,3
TM40E/N10UN	10	40	20	6,3
TM40E/N8UN	8	40	20	6,3
TM40E/N6UN	6	40	20	6,3

INSERTS	SCREW 	WRENCH 	WRENCH 
TM14...	ISM030070-TM14	T10	-
TM21...	ISM035100-TM21	T15	W15
TM30...	ISM040100-TM30	T15	W15
TM40...	ISM050140-TM40	T20	W20



INSERTS & ACCESSORIES

TM-W55°

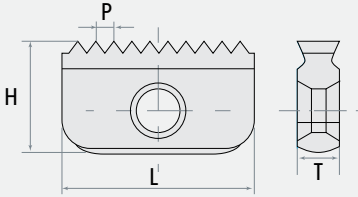

PRODUCT CODE	TPI	DIMENSIONS (mm)		
		L	H	T
TM14E/N24W	24	14	7,5	3,1
TM14E/N20W	20	14	7,5	3,1
TM14E/N19W	19	14	7,5	3,1
TM14E/N16W	16	14	7,5	3,1
TM14E/N14W	14	14	7,5	3,1
TM14E/N11W	11	14	7,5	3,1
TM21E/N20W	20	21	12	4,7
TM21E/N19W	19	21	12	4,7
TM21E/N16W	6	21	12	4,7
TM21E/N14W	14	21	12	4,7
TM21E/N11W	11	21	12	4,7
TM30E/N16W	16	30	16	5,5
TM30E/N14W	14	30	16	5,5
TM30E/N11W	11	30	16	5,5
TM40E/N11W	11	40	20	6,3
TM40E/N8W	8	40	20	6,3

INSERTS & ACCESSORIES

TM-BSPT 55°

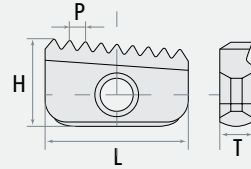

PRODUCT CODE	TPI	DIMENSIONS (mm)		
		L	H	T
TM14E/N19BSPT	19	14	7,5	3,1
TM14E/N14BSPT	14	14	7,5	3,1
TM21E/N14BSPT	14	21	12	4,7
TM21E/N11BSPT	11	21	12	4,7
TM30E/N11BSPT	11	30	16	5,5
TM40E/N11BSPT	11	40	20	6,3

INSERTS & ACCESSORIES

TM-NPT

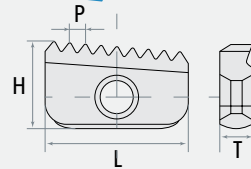

PRODUCT CODE	TPI	DIMENSIONS (mm)		
		L	H	T
TM14E/N18NPT	18	14	7,5	3,1
TM14E/N14NPT	14	14	7,5	3,1
TM21E/N14NPT	14	21	12	4,7
TM21E/N11.5NPT	11,5	21	12	4,7
TM30E/N11.5NPT	11,5	30	16	5,5
TM30E/N8NPT	8	30	16	5,5
TM40E/N11.5NPT	11,5	40	20	6,3
TM40E/N8NPT	8	40	20	6,3



T-SLOT GROOVE MILLING

END MILL

FM8-90

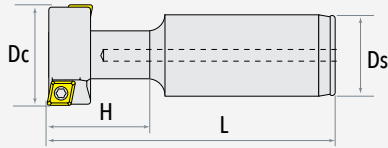

PRODUCT CODE		DIMENSIONS (mm)				INSERTS
		D _c	D _s	H	L	
EM8-90-25-C25-110-02CC06	2	25	25	32	110	CCMT0602...
EM8-90-32-C32-120-02CP08	2	32	32	44	120	CPMT0802...
EM8-90-40-C32-130-02CC09	4	40	32	50	130	CCMT09T3...
EM8-90-50-C32-140-02CC12	4	50	32	61	140	CCMT1204...

INSERTS & ACCESSORIES

CPMT

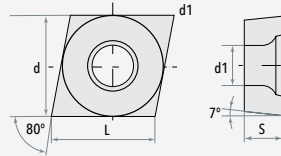

INSERTS	SCREW	WRENCH	WRENCH
CCMT0602...	ISM025060-CC06	T08	-
CPMT0802...	ISM025060-CP08	T08	-
CCMT09T3...	ISM040100-CC09	T15	W15
CCMT1204...	ISM050110-CC12	T20	W20



FACE MILL

FM8-GM16

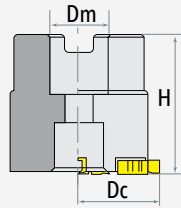

PRODUCT CODE		DIMENSIONS (mm)			INSERTS
		D_c	D_m	H	
FM8-54R04GM16-22A	4	54	22	40	GM16**
FM8-63R05GM16-22A	5	63	22	40	GM16**
FM8-80R06GM16-27A	6	80	27	50	GM16**

END MILL

EM8-GM16

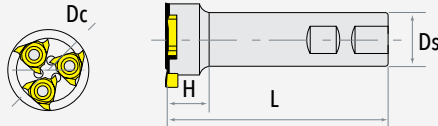

PRODUCT CODE		DIMENSIONS (mm)				INSERTS
		D_c	D_s	H	L	
EM8-20-W16-80-01-GM16	1	20	16	30	90	GM16**
EM8-25-C20-100-01-GM16	1	25	20	40	110	GM16**
EM8-32-C25-120-02-GM16	2	32	25	55	130	GM16**
EM8-40-C32-150-03-GM16	3	40	32	70	140	GM16**

INSERTS & ACCESSORIES

GM16

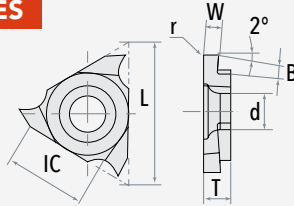

PRODUCT CODE	DIMENSIONS (mm)						
	W	B	r	L	IC	T	D
GM16R/L045	0,45	0,8	0,03	16	3/8"	3,18	4,5
GM16R/L050	0,50	1,0	0,05	16	3/8"	3,18	4,5
GM16R/L060	0,60	1,0	0,05	16	3/8"	3,18	4,5
GM16R/L065	0,65	1,4	0,05	16	3/8"	3,18	4,5
GM16R/L070	0,70	1,4	0,05	16	3/8"	3,18	4,5
GM16R/L075	0,75	2,0	0,10	16	3/8"	3,18	4,5
GM16R/L080	0,80	2,0	0,10	16	3/8"	3,18	4,5
GM16R/L085	0,85	2,0	0,10	16	3/8"	3,18	4,5
GM16R/L090	0,90	2,0	0,10	16	3/8"	3,18	4,5
GM16R/L095	0,95	2,0	0,10	16	3/8"	3,18	4,5
GM16R/L100	1,00	2,2	0,10	16	3/8"	3,18	4,5
GM16R/L110	1,10	2,2	0,10	16	3/8"	3,18	4,5
GM16R/L115	1,15	2,2	0,10	16	3/8"	3,18	4,5
GM16R/L120	1,20	2,2	0,10	16	3/8"	3,18	4,5
GM16R/L125	1,25	2,2	0,10	16	3/8"	3,18	4,5
GM16R/L130	1,30	2,2	0,10	16	3/8"	3,18	4,5
GM16R/L135	1,35	2,2	0,10	16	3/8"	3,18	4,5
GM16R/L140	1,40	2,2	0,10	16	3/8"	3,18	4,5
GM16R/L145	1,45	2,2	0,10	16	3/8"	3,18	4,5
GM16R/L150	1,50	2,4	0,10	16	3/8"	3,18	4,5
GM16R/L155	1,55	2,4	0,10	16	3/8"	3,18	4,5
GM16R/L160	1,60	2,4	0,10	16	3/8"	3,18	4,5
GM16R/L165	1,65	2,4	0,10	16	3/8"	3,18	4,5
GM16R/L170	1,70	2,4	0,10	16	3/8"	3,18	4,5
GM16R/L175	1,75	2,4	0,10	16	3/8"	3,18	4,5



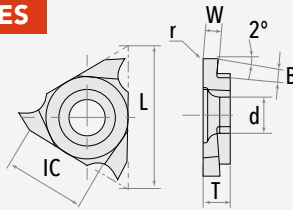

INSERTS & ACCESSORIES

GM16



PRODUCT CODE	DIMENSIONS (mm)						
	W	B	r	L	IC	T	D
GM16R/L180	1,80	2,4	0,10	16	3/8"	3,18	4,5
GM16R/L185	1,85	2,4	0,10	16	3/8"	3,18	4,5
GM16R/L190	1,90	2,4	0,10	16	3/8"	3,18	4,5
GM16R/L200	2,00	2,7	0,15	16	3/8"	3,18	4,5
GM16R/L210	2,10	2,7	0,15	16	3/8"	3,18	4,5
GM16R/L215	2,15	2,7	0,15	16	3/8"	3,18	4,5
GM16R/L220	2,20	2,7	0,15	16	3/8"	3,18	4,5
GM16R/L225	2,25	2,7	0,15	16	3/8"	3,18	4,5
GM16R/L230	2,30	2,7	0,15	16	3/8"	3,18	4,5
GM16R/L240	2,40	2,7	0,15	16	3/8"	3,18	4,5
GM16R/L250	2,50	3,0	0,15	16	3/8"	3,18	4,5
GM16R/L260	2,60	3,0	0,15	16	3/8"	3,18	4,5
GM16R/L265	2,65	3,0	0,15	16	3/8"	3,18	4,5
GM16R/L270	2,70	3,0	0,15	16	3/8"	3,18	4,5
GM16R/L275	2,75	3,0	0,15	16	3/8"	3,18	4,5
GM16R/L280	2,80	3,0	0,15	16	3/8"	3,18	4,5

INSERTS	SCREW 	WRENCH 	WRENCH 
GM16**	ISM040100-GM16	T15	W15

CUTTER DIAMETER

The Best Cutter Diameter ($\varnothing D$) should be selected upon the workpiece dimensions.

$$D \cong 1.3 - 1.5 WOC$$

If the machine power is limited or the workpiece is too wide, select a cutter diameter that takes more than two passes or that matches the power of machine.

When the appropriate cutter diameter is not available, proper cutter position will give good results.

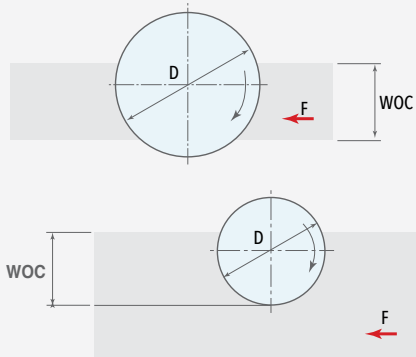

CONVENTIONAL MILLING (UP MILLING)

The feed direction of the workpiece is opposite to that of cutter rotation. The chip thickness starts at zero and increases to the maximum at the end of cut. In Up Milling, the insert wear is severe with excessive friction and high temperature caused by the rubbing or burnishing effect in the insert.

CHANNEL MILLING (UP AND DOWN MILLING)

The cutter position is in the middle of the workpiece and the cutting force is alternately changed in the radial direction. It causes vibration when the spindle structure is weak. Channel Milling is a combination of conventional and climb milling. When Channel Milling is necessary use positive geometry cutters at reduced speeds and feeds with coolant.

CLIMB MILLING (DOWN MILLING)

Climb Milling is normally recommended. The feed direction of workpiece is the same as that of cutter rotation. So the chip thickness starts from the maximum and decreases to zero at the end of cut. The tool life is long with less heat and minimum work hardening of workpiece.

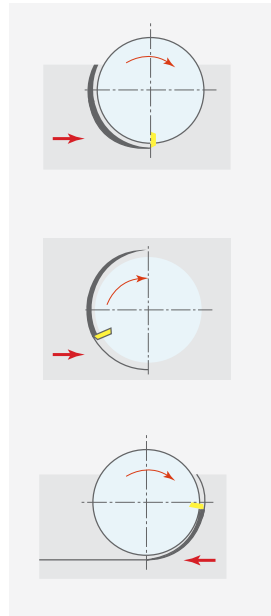



RAKE ANGLE

- Easy chip removal
- Apply to all materials under 300 brinell hardness. Especially on light setups and low HP40 Taper or smaller milling machines.
- Apply to cast iron which gives short chip. Positive rake angle type is popular and this increases machine efficiency and reduces heat generation. It is possible to reduce machine damage compared to machining with negative rake angle insert, which require high power consumption.
- For milling hard materials that require high edge strength, negative rake angle inserts are preferable.

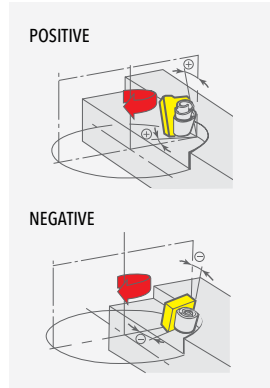

SELECTION OF ENTERING ANGLE

- Entering angle of face mill is usually less than 90° for easy chip flow and increased edge strength.
- Generally, entering angle are 45° and 75° with the most popular entering angle being 45° . This is economical and enables increased efficiency of power consumption in milling from finishing to roughing.
- 45° entering angle is suitable for heavy cutting and provides excellent cutting edge strength. With 45° entering angle, axial cutting force; this is nearly equal to radial cutting force this is very effective for long overhang milling.
- When corner damage is likely to occur in milling of cast iron, 45° entering angle is recommended.
- When it is difficult to position the cutter owing to workpiece shape, bigger entering angles are preferable.

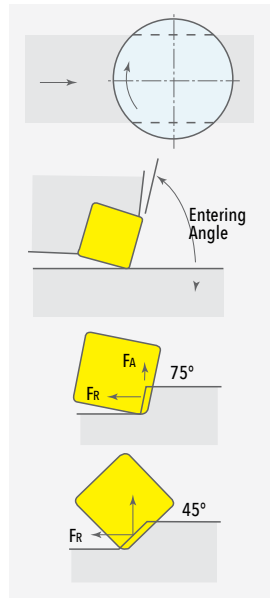

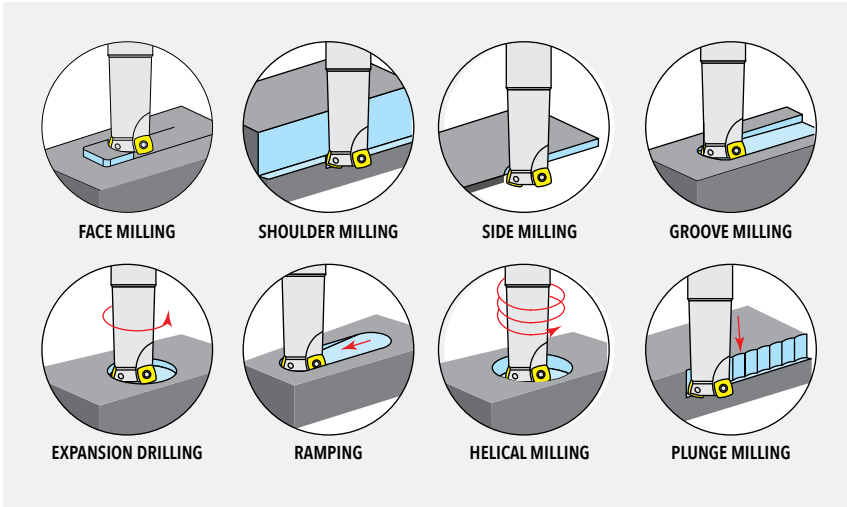

THE GOLDEN RULE – THICK TO THIN

When milling, you always need to consider how the chips are being formed. It is the cutter position that forms the chips and you should always aim for thick chips on entry and thin chips on exit to ensure a stable milling process.

Remember the golden rule in milling - thick to thin - to ensure the lowest chip thickness possible when exiting a cut.

Milling evolved into a method of machining a broad range of operations. In addition to conventional applications, milling is a strong alternative for producing holes, threads, cavities and surfaces that used to be turned, drilled or tapped.

CONSIDERATIONS FOR MILLING OPERATIONS

The milled configuration

The features to be milled have to be carefully considered. These can be located deep, requiring extended tooling, or contain interruptions and inclusions.

The component

Workpiece surfaces can be demanding, with cast skin or forging scale. In cases of bad rigidity, caused by thin sections or weak clamping, dedicated tooling and strategies have to be used. The workpiece material and its machinability must also be analyzed to establish optimal cutting data.

The machine

The milling method will determine the type of machine needed. Face/shoulder or slot milling can be performed in 3-axis machines, while milling 3D profiles require alternatively 4- or 5-axis machines.

Turning centres today often have milling capability due to driven tools, and machining centres often have turning capability. CAM developments mean that 5-axis machines are increasingly common. They offer increased flexibility, but stability can be a limitation.



UP MILLING	DOWN MILLING
In up milling, cutter rotates against the direction of table feed.	In down milling, cutter rotates along the direction of table feed.
Chip load on teeth (or uncut chip thickness) increases gradually from zero at the point of engagement to maximum at the point of disengagement.	Chip load on teeth (or uncut chip thickness) decreases gradually from maximum at the point of engagement to zero at disengagement.
Here tooth experience gradual loading as contact starts with zero chip load.	Here tooth experience impact loading as tooth engages suddenly with maximum chip load.
With horizontal axis milling machine, cutting force in up milling mode is directed upward, and thus it tends to lift off the workpiece from the worktable. Accordingly, rigid and expensive fixture is required for firmly mounting the workpiece.	In down milling mode, the cutting force is directed downward, and thus it tends to press the workpiece rather than lift off. So cheaper fixture can be employed.
Thin workpiece samples, if machined using up milling mode, may get distorted due to upward cutting force.	Chances of distortion of thin workpiece samples are less with down milling mode if proper support in bottom is provided.
Due to gradual buildup of chip load in up milling, heat generation is also high. So there exists a tendency of chip welding with the teeth.	Tendency of chip welding is less in down milling but chip re-deposition on finished surface occurs frequently that may degrade quality of finished surface.
Burr is formed only on unfinished surface ahead of the tool feed; however, majority of such burr is removed in the subsequent passes.	Burr is formed at finished surface in opposite side of the tool feed. Thus these burrs are not removed automatically. This leads to degraded cutting quality.
At the beginning of engagement, teeth rub with lay or feed marks on the machined surface. This improves surface finish.	No such rubbing action takes place, and thus lay marks remains intact on the machined surface.
Besides improving surface finish, rubbing during engagement may result in undesirable work hardening owing to significant heat generation.	Chance of work hardening is minimal with down milling.
In up milling mode, no chipping action occurs on teeth of the cutting tool due to gradual contact. Accordingly, tool wear rate is relatively low.	Due to impact loading at engagement, chipping occurs and it may cause notch wear. Thus tool wear rate is high. There also exists a chance of catastrophic failure of the teeth.
No backlash eliminator is required.	Backlash eliminator is required, especially if the milling machine is an older one.
If the workpiece or cutter material is brittle (such as ceramic), up milling is always preferred.	Down milling is not a good choice if the workpiece material is brittle.



TROUBLE SHOOTING

	CAUSE	SOLUTIONS
VIBRATION	<ul style="list-style-type: none">• Weak fixture	<ul style="list-style-type: none">• Assess the direction of the cutting forces and provide adequate support or improve the fixture• Reduce the cutting forces by decreasing the cutting depth, a_p• Select a coarse and differentially pitched cutter with a more positive cutting action• Select a geometry with a small corner radius and small parallel land• Select a fine-grain, uncoated insert, or a thinner coating• Avoid machining where the workpiece has poor support against the cutting forces
	<ul style="list-style-type: none">• Axially weak workpiece	<ul style="list-style-type: none">• Consider a square shoulder cutter (90-degree entering angle) with positive geometry• Select an insert with L-geometry• Decrease axial cutting force – lower depth of cut, smaller corner radius and parallel land• Select a coarse-pitch cutter with differential pitch• Check tool wear• Check tool holder run-out• Improve clamping of tool
	<ul style="list-style-type: none">• Too long tool overhang	<ul style="list-style-type: none">• Minimize overhang• Use coarse-pitch cutters with differential pitch• Balance radial and axial cutting forces – 45 degree entering angle, large corner radius or round insert cutter• Increase feed per tooth• Use a light-cutting insert geometry• Reduce axial depth of cut, a_f• Use up milling in finishing• Use oversized cutters and Coromant Capto® coupling adaptors• For solid carbide end mills and exchangeable-head mills, try a tool with fewer teeth and/or a higher helix angle
	<ul style="list-style-type: none">• Milling square shoulder with weak spindle	<ul style="list-style-type: none">• Select smallest possible cutter diameter• Select a positive, light-cutting cutter and insert• Try up milling• Check spindle deflection to see if acceptable for machine
	<ul style="list-style-type: none">• Irregular table feed	<ul style="list-style-type: none">• Try up milling• Tighten machine feed mechanism: adjust the feed screw on CNC machine• Adjust the locking screw or replace the ball screw on conventional machines



	CAUSE	SOLUTIONS
CHIP JAMMING	<ul style="list-style-type: none"> • Insert corner damage • Edge chipping and breakage • Re-cutting of chips 	<ul style="list-style-type: none"> • Improve chip evacuation by using rich and well directed cutting fluid or compressed air • Reduce feed, fz • Split deep cuts into several passes • Try up milling in deep slotting • Use coarse pitch cutters • Use solid carbide end mills or exchangeable-head mills with two or maximum three cutting edges and/or a higher helix angle
RE-CUTTING OF CHIPS	<ul style="list-style-type: none"> • Cutting edge fractures • Harmful for tool life and security • Chip jamming 	<ul style="list-style-type: none"> • Evacuate chips effectively by compressed air or copious cutting fluid flow – preferably internal coolant • Change cutter position and tool path strategy • Reduce feed, fz • Split deep cuts into several passes
POOR SURFACE FINISH	<ul style="list-style-type: none"> • Excessive feed per revolution 	<ul style="list-style-type: none"> • Set cutter axially or classify inserts. Check height with indicator • Check spindle run-out and cutter mounting surfaces • Decrease feed per rev to max. 70% of the width of the parallel land • Use wiper inserts if possible (for finishing operations)
	<ul style="list-style-type: none"> • Built-up edge formation 	<ul style="list-style-type: none"> • Increase cutting speed, vc, to elevate machining temperature • Turn off cutting fluid • Use sharp cutting edge inserts, with smooth rake side • Use positive insert geometry • Try a cermet grade with higher cutting data
	<ul style="list-style-type: none"> • Back-cutting 	<ul style="list-style-type: none"> • Check spindle tilt (approx. 0.10 mm/1000 mm (0.004 inch/39.370 inch)) • Axial run-out, TIR, of spindle should not exceed 7 microns during finishing • Reduce the radial cutting forces (decrease the depth of cut, ap) • Select a smaller cutter diameter • Check the parallelism on the parallel lands and on wiper insert used (should not be standing on "heel or toe") • Make sure the cutter is not wobbling – adjust the mounting surfaces
<ul style="list-style-type: none"> • Workpiece frittering 	<ul style="list-style-type: none"> • Decrease feed, fz • Select a close or extra-close pitch cutter • Re-position the cutter to give a thinner chip at exit • Select a more suitable entering angle (45°) and lighter cutting geometry • Choose a sharp insert • Monitor flank wear to avoid excessive wear 	



ADDRESS

ROOM 1601, NO. 399 MINHE ROAD, ZHENHAI,
NINGBO CHINA, 315202

GET IN TOUCH

PHONE: **+86 574 8659 2189** FAX: **+86 574 8659 3892**

NTTOOLS2017@GMAIL.COM WWW.NICHE-TOOL.COM